



DC Type

SMJD-3625012H-XXN1



Product Brief

Description

- This reference module is based on White Colored surface-mount LED comes in standard package dimension. Package Size : 3.5x3.5x2.29mm
- The package design coupled with careful selection of component materials allow these products to perform with high reliability .

Features and Benefits

- High Intensity output and high luminance
- High Efficacy
- Compatible with 3rd party optics
- Lead free product
- RoHS compliant

Key Applications

- Street Lighting
- Area Lighting
- Residential Lighting
- Urban Lighting

Table 1. Order Code

Nominal CCT (K)	CRI	Lens Type	Order Code
6500	70	No lens	SMJD-3625012H-XXN100D93A057ALL
5700		No lens	SMJD-3625012H-XXN100D93B057ALL
5000		No lens	SMJD-3625012H-XXN100D93C057ALL
4000		No lens	SMJD-3625012H-XXN100E01E057ALL
3500		No lens	SMJD-3625012H-XXN100D76F057ALL
3000		No lens	SMJD-3625012H-XXN100D76G057ALL
2700		No lens	SMJD-3625012H-XXN100D60H057ALL
6500		80	No lens
5700	No lens		SMJD-3625012H-XXN100D86B058ALL
5000	No lens		SMJD-3625012H-XXN100D86C058ALL
4000	No lens		SMJD-3625012H-XXN100D86E058ALL
3500	No lens		SMJD-3625012H-XXN100D52F058ALL
3000	No lens		SMJD-3625012H-XXN100D42G058ALL
2700	No lens		SMJD-3625012H-XXN100D42H058ALL



Table of Contents

Index	
• Product Brief	
• Order Code	
• Table of Contents	
• Performance Characteristics	
• Absolute Maximum Ratings	
• Characteristic Graph	
• Relative Spectral Distribution	
• Color Bin Structure	
• Mechanical Dimensions	
• Circuit Drawing	
• Product Nomenclature	
• Marking Information	
• Part List	
• Label Information	
• Packing Specification	
• Precaution for Use	
• Storage before use	
• Guidelines for properly working with Module	
• Company Information	



Performance Characteristics

Table 2. Electro Optical Characteristics Tc = 25°C, I_F = 700mA

Parameter	Symbol	Value			Unit	Remark 1	Remark 2
		Min.	Typ.	Max.			
Luminous Flux	Φ_V [2]	3680	3930	-	lm	A, B, C rank	Ra70
		3840	4010	-		E rank	
		3510	3760	-		F,G rank	
		3350	3600	-	lm	H rank	
		3690	3860	-		A,B,C,E rank	
		3340	3520	-		F rank	
		3130	3420	-		G,H rank	
Luminous Efficiency	LPW	-	164	-	Lm/W	A, B, C rank	Ra70
		-	167	-		E rank	
		-	157	-		F,G rank	
		-	150	-	Lm/W	H rank	
		-	161	-		A,B,C,E rank	
		-	147	-		F rank	
		-	143	-		G,H rank	
Correlated Color Temperature [3]	CCT	6000	6500	7000	K	A05	
		5300	5700	6000		B05	
		4700	5000	5300		C05	
		3700	4000	4200		E05	
		3200	3500	3700		F05	
		2900	3000	3200		G05	
		2600	2700	2900		H05	
CRI	Ra	70	-	-	-		
Color Consistency	-	-	-	5	SDC M		
Input Voltage [4]	V _{in}	32	34.3	38	Vdc		
Input Current	I _F	-	0.7	-	A	-	
Power	P	-	24	-	W		
Viewing Angle	2 $\Theta_{1/2}$	-	120	-	deg.		

Notes :

1. The above data were tested at Tc= 25°C.
2. Φ_V is the total luminous flux output measured with an integrated sphere.
3. Correlated Color Temperature is derived from the CIE 1931 Chromaticity diagram.
4. To use the module properly, recommend to drive the module by a Constant Current Source (CCS). But the Maximum output voltage of the CCS should be limited by referring this sheet



Absolute Maximum Ratings

Table3. Absolute Maximum Ratings, T_c= 25°C

Parameter	Symbol	Unit	Value	Remark
Power Consumption	P	W	50	P _{Typ.} = 24W
Driving Current ⁽²⁾	I _F	A	1.4	I _{F_Typ.} = 0.7A
Operating Temperature ⁽³⁾	T _c	°C	- 40 ~ 85	Reference point
Storage Temperature	T _{stg}	°C	- 40 ~ 100	With no power
ESD Sensitivity	-		±4,000V HBM	Class 2 JESD22-A114-E

ILLUSTRATION 1: How to predict components temperature ⁽⁴⁾



Notes :

- (1) All guarantee are based on the Absolute Maximum Ratings listed.
- (2) Please use a Constant Current Source (CCS) to drive the module, the typical V_F of module is around 34.3VDC and V_{F_MAX} is around 38VDC, respectively.
- (3) Operating temperature was tested at the assigned T_c point on the PCB.
- (4) To ensure the module works properly, DO NOT let the T_c upper than 85 °C;



Characteristic Graph

Fig 1. Relative Spectral Distribution vs. Wavelength Characteristic

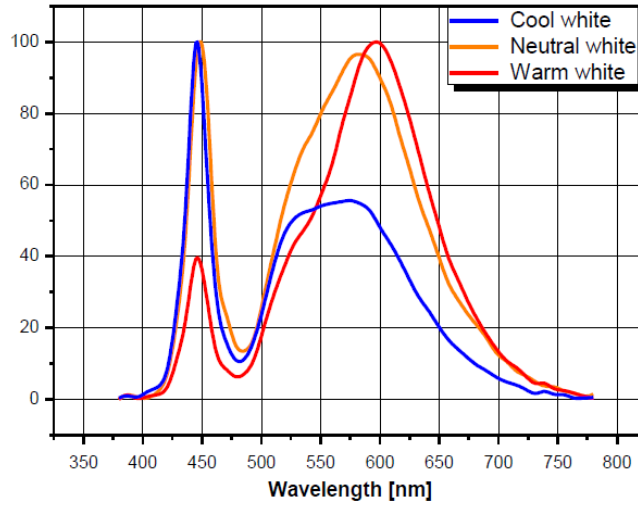
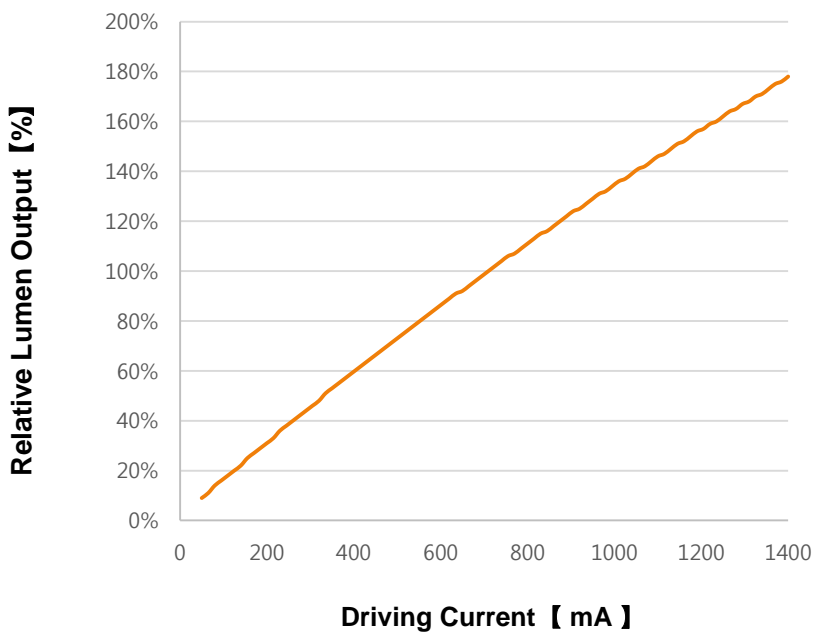

Fig 2. Forward Current vs. Relative Luminous Flux, Tc= 25°C





Characteristic Graph

Fig 3. Forward Current vs. Forward Voltage, $T_c = 25^\circ\text{C}$

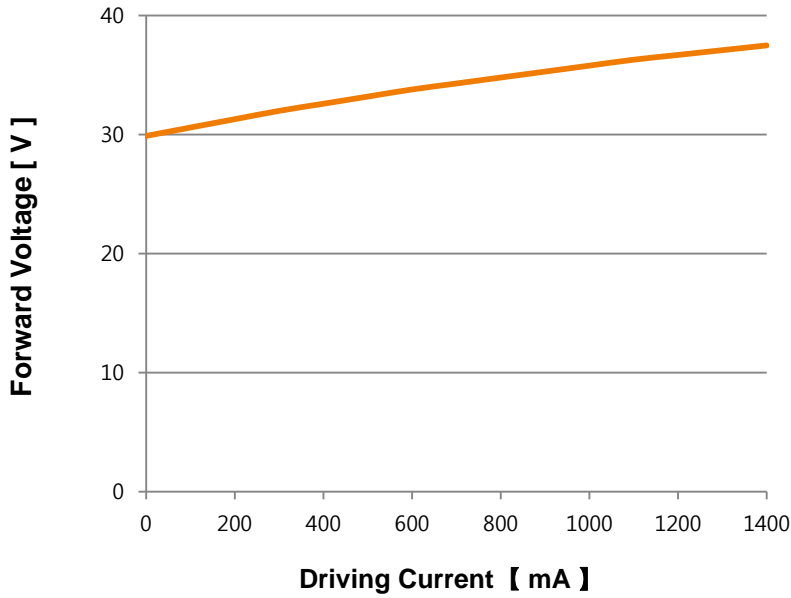
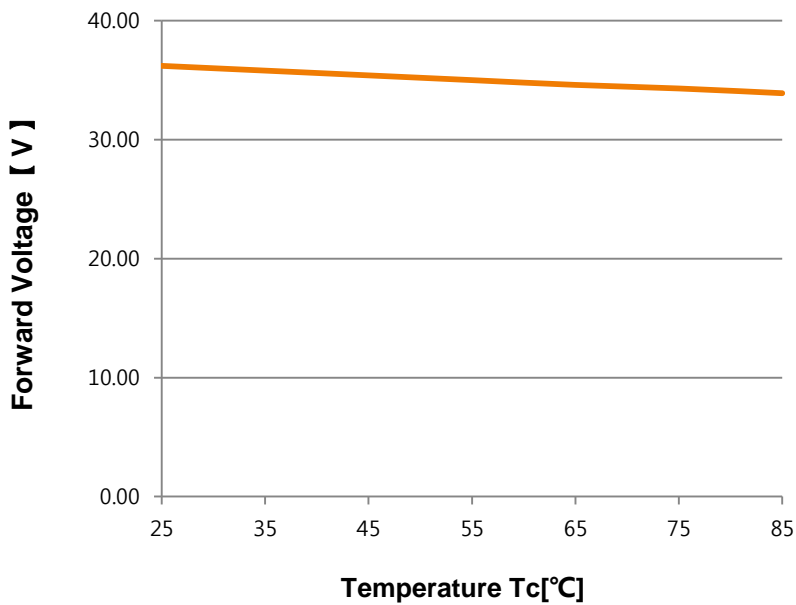

Fig 4. Forward voltage vs. Temperature, $I_F = 700\text{mA}$





Characteristic Graph

Fig 5. Flux and Efficacy vs. Temperature (at $I_F=700\text{mA}$)

Tc [°C]	Flux[%]	Efficacy[%]
25	100.0	100.0
45	98.8	99.8
65	97.2	99.1
85	95.2	97.8

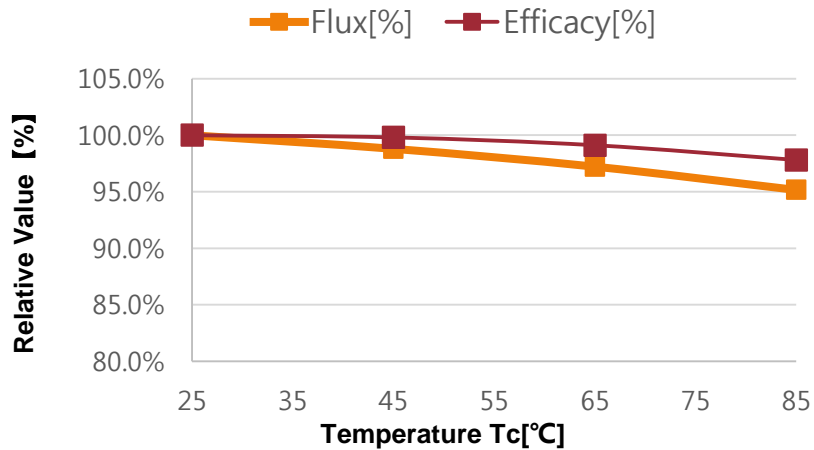
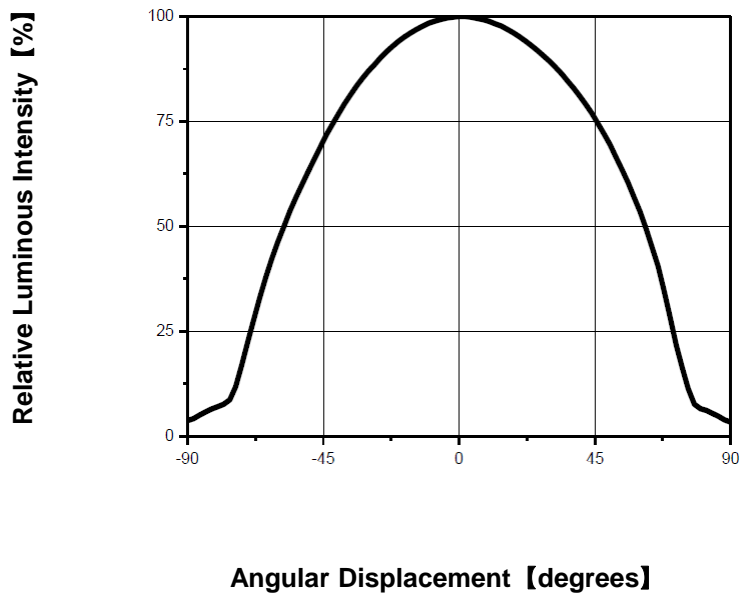

Fig 6. Typical Spatial Distribution





Color Bin Structure

Fig 7. CIE Chromaticity Diagram

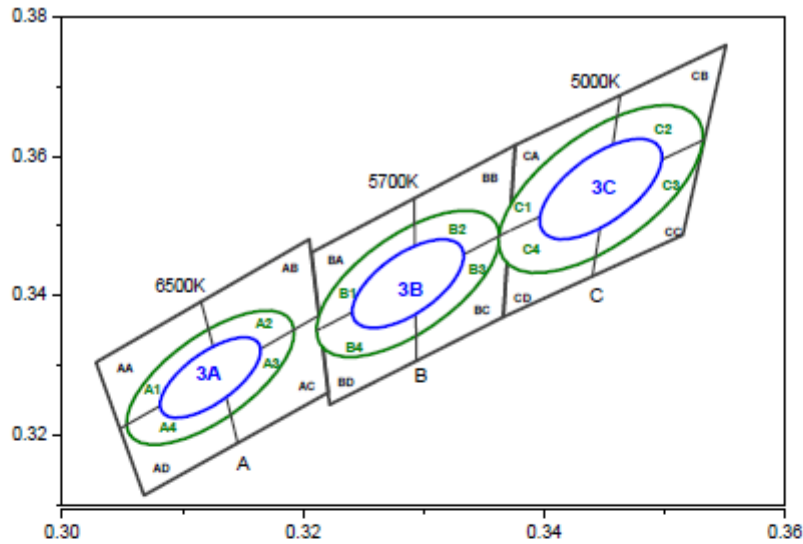

6500K 3Step		5700K 3Step		5000K 3Step			
3A		3B		3C			
Center point	0.3123 : 0.3282	Center point	0.3287 : 0.3417	Center point	0.3447 : 0.3553		
Major Axis a	0.0066	Major Axis a	0.0072	Major Axis a	0.0081		
Minor Axis b	0.0027	Minor Axis b	0.0032	Minor Axis b	0.0035		
Ellipse	58	Ellipse	59	Ellipse	60		
Rotation Angle		Rotation Angle		Rotation Angle			
6500K 5Step		5700K 5Step		5000K 5Step			
5A		5B		5C			
Center point	0.3123 : 0.3282	Center point	0.3287 : 0.3417	Center point	0.3447 : 0.3553		
Major Axis a	0.0110	Major Axis a	0.0119	Major Axis a	0.0135		
Minor Axis b	0.0045	Minor Axis b	0.0052	Minor Axis b	0.0059		
Ellipse	58	Ellipse	59	Ellipse	60		
Rotation Angle		Rotation Angle		Rotation Angle			
AA	AB	AC	AD				
CIE X	CIE Y	CIE X	CIE Y	CIE X	CIE Y	CIE X	CIE Y
0.3028	0.3304	0.3115	0.3393	0.3131	0.3290	0.3048	0.3209
0.3048	0.3209	0.3131	0.3290	0.3146	0.3187	0.3068	0.3113
0.3131	0.329	0.3213	0.3371	0.3221	0.3261	0.3146	0.3187
0.3115	0.3393	0.3205	0.3481	0.3213	0.3371	0.3131	0.329
BA	BB	BC	BD				
CIE X	CIE Y	CIE X	CIE Y	CIE X	CIE Y	CIE X	CIE Y
0.3207	0.3462	0.3292	0.3539	0.3293	0.3423	0.3215	0.3353
0.3215	0.3353	0.3293	0.3423	0.3294	0.3306	0.3222	0.3243
0.3293	0.3423	0.3371	0.3493	0.3366	0.3369	0.3294	0.3306
0.3292	0.3539	0.3376	0.3616	0.3371	0.3493	0.3293	0.3423
CA	CB	CC	CD				
CIE X	CIE Y	CIE X	CIE Y	CIE X	CIE Y	CIE X	CIE Y
0.3376	0.3616	0.3463	0.3687	0.3452	0.3558	0.3371	0.3493
0.3371	0.3493	0.3452	0.3558	0.344	0.3428	0.3366	0.3369
0.3452	0.3558	0.3533	0.3624	0.3514	0.3487	0.344	0.3428
0.3463	0.3687	0.3551	0.376	0.3533	0.3624	0.3452	0.3558



Color Bin Structure

Fig 8. CIE Chromaticity Diagram

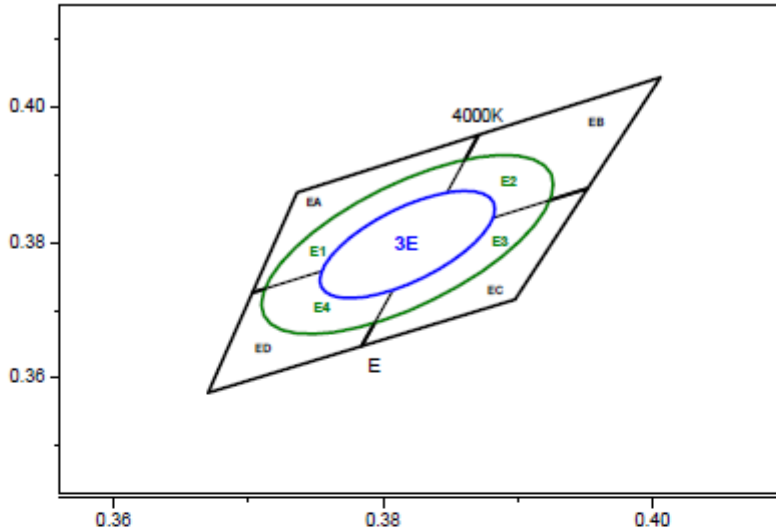

4000K 3Step

3E	
Center point	0.3818 : 0.3797
Major Axis a	0.0094
Minor Axis b	0.0041
Ellipse	
Rotation Angle	53.4

4000K 5Step

5E	
Center point	0.3818 : 0.3797
Major Axis a	0.0157
Minor Axis b	0.0067
Ellipse	
Rotation Angle	53

EA		EB		EC		ED	
CIE X	CIE Y	CIE X	CIE Y	CIE X	CIE Y	CIE X	CIE Y
0.3736	0.3874	0.3871	0.3959	0.3828	0.3803	0.3703	0.3726
0.3703	0.3726	0.3828	0.3803	0.3784	0.3647	0.3670	0.3578
0.3828	0.3803	0.3952	0.3880	0.3898	0.3716	0.3784	0.3647
0.3871	0.3959	0.4006	0.4044	0.3952	0.3880	0.3828	0.3803



Color Bin Structure

Fig 9. CIE Chromaticity Diagram

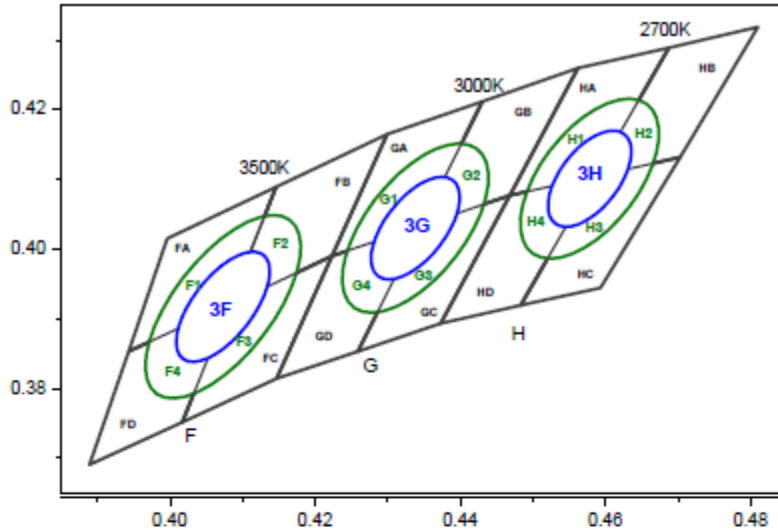

3500K 3Step		3000K 3Step		2700K 3Step					
3F		3G		3H					
Center point	0.4073 : 0.3917	Center point	0.4338 : 0.4030	Center point	0.4578 : 0.4101				
Major Axis a	0.0093	Major Axis a	0.0086	Major Axis a	0.0080				
Minor Axis b	0.0042	Minor Axis b	0.0042	Minor Axis b	0.0041				
Ellipse	54	Ellipse	54	Ellipse	54				
Rotation Angle	54	Rotation Angle	54	Rotation Angle	54				
3500K 5Step		3000K 5Step		2700K 5Step					
5F		5G		5H					
Center point	0.4073 : 0.3917	Center point	0.4338 : 0.4030	Center point	0.4578 : 0.4101				
Major Axis a	0.0155	Major Axis a	0.0142	Major Axis a	0.0132				
Minor Axis b	0.0068	Minor Axis b	0.0068	Minor Axis b	0.0068				
Ellipse	54	Ellipse	54	Ellipse	54				
Rotation Angle	54	Rotation Angle	54	Rotation Angle	54				
FA	FB	FC	FD	GA	GB	GC	GD		
CIE X	CIE Y	CIE X	CIE Y	CIE X	CIE Y	CIE X	CIE Y	CIE X	CIE Y
0.3996	0.4015	0.4146	0.4089	0.4082	0.3920	0.3943	0.3853	0.3943	0.3853
0.3943	0.3853	0.4082	0.3920	0.4017	0.3751	0.3889	0.3690	0.4082	0.392
0.4082	0.392	0.4223	0.3990	0.4147	0.3814	0.4017	0.3751	0.4146	0.4089
0.4146	0.4089	0.4299	0.4165	0.4223	0.3990	0.4082	0.3920	0.4299	0.4165
GA	GB	GC	GD	HA	HB	HC	HD		
CIE X	CIE Y	CIE X	CIE Y	CIE X	CIE Y	CIE X	CIE Y	CIE X	CIE Y
0.4299	0.4165	0.4430	0.4212	0.4345	0.4033	0.4223	0.399	0.4562	0.426
0.4223	0.3990	0.4345	0.4033	0.4259	0.3853	0.4147	0.3814	0.4468	0.4077
0.4345	0.4033	0.4468	0.4077	0.4373	0.3893	0.4259	0.3853	0.4585	0.4104
0.4430	0.4212	0.4562	0.426	0.4468	0.4077	0.4345	0.4033	0.4687	0.4289
HA	HB	HC	HD	HA	HB	HC	HD		
CIE X	CIE Y	CIE X	CIE Y	CIE X	CIE Y	CIE X	CIE Y	CIE X	CIE Y
0.4562	0.426	0.4687	0.4289	0.4585	0.4104	0.4468	0.4077	0.4585	0.4104
0.4468	0.4077	0.4585	0.4104	0.4483	0.3919	0.4373	0.3893	0.4483	0.4104
0.4585	0.4104	0.4703	0.4132	0.4593	0.3944	0.4483	0.3919	0.4687	0.4289
0.4687	0.4289	0.481	0.4319	0.4703	0.4132	0.4585	0.4104		



Mechanical Dimensions

Fig 10. Mechanical Diagram

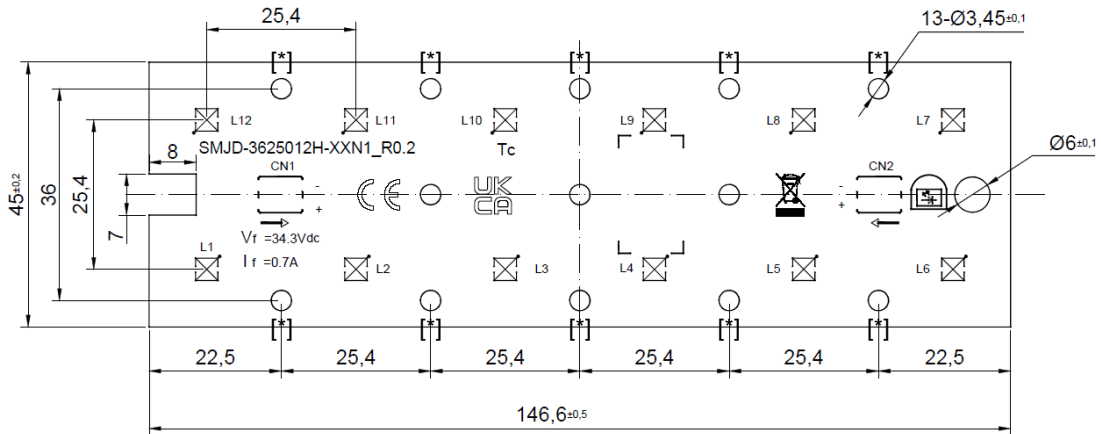

- (1) All dimensions are in mm
- (2) Not to Scale
- (3) Module thickness 3.4 ± 0.1 mm
- (4) [*] Marked $\Phi 3.45$ (10 holes /PCB) holes



Circuit Drawing

Fig 11. Schematic Diagram

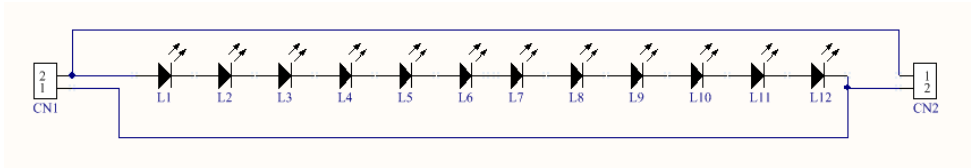



Product Nomenclature

Product Name Rule:

S M J D - 36 25 012 H - XX N 1
 ① ② ③ ④ ⑤ ⑥ ⑦ ⑧

① : SMJD – Seoul DC Module

② ~ ⑧ : Refer to below table

Voltage				Power				LED Qty.				LED Type	Customer (Free)		Lens					
②		③		④				⑤	⑥		⑦	⑧								
3	6	2	5	0	1	2	H	XX		N	1									
0	0	0	0	0	0	0	0	0	0	0	0	0	H	Z5 series	XX	Reference	N	Normal	1	Version
1	10V	1	1V	1	10W	1	1W	1	100EA	1	10EA	1	1EA				D	Dimming		
2	20V	2	2V	2	20W	2	2W	2	200EA	2	20EA	2	2EA							
3	30V	3	3V	3	30W	3	3W	3	300EA	3	30EA	3	3EA							
...								
9	90V	9	9V	9	90W	9	9W	9	900EA	9	90EA	9	9EA							
A	100V			A	100W			A	1000EA											
B	110V			B	110W															
...															
Z	350V			Z	350W															

Comments Rule:

(00 WN 70)
A B C

Lens Type		CCT		CRI	
A		B		C	
00		WN		70	
00	No lens	W0	6500K	70	CRI70
			5700K		
			5000K		
		WN	4000K		
		WW	3000K		
			2700k		



Product Nomenclature

Characteristics Rule:

00 E01 E05 7 ALL
A B C D E

Lens type		Flux bin		CCT bin		CRI bin		VF Bin ⁽¹⁾	
A		B		C		D		E	
00		E01		E05		7		ALL	
00	No lens	D93	3930lm	A05	6500K 5-step	7	CRI70	ALL	DC 32~38V
		E01	4010lm	B05	5700K 5-step				
		D76	3760lm	C05	5000K 5-step				
		D60	3600lm	E05	4000K 5-step				
		D86	3860lm	F05	3500K 5-step				
		D52	3520lm	G05	3000K 5-step				
		D42	3420lm	H05	2700K 5-step				



Marking Information

Fig 12. Marking Point

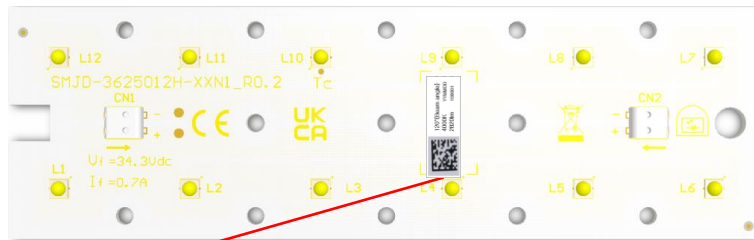

Marking point

QR Code Information



120°(Beam angle)	①
4000K YYMMDD	②
4010lm 100001	③

QR Code Information								
Items	Factory	SAP Code	SMT Date	Rank Information	Line No.	Lot No.	Product	Notes
Digits	1 Digit	7 Digit	6 Digit	10 Digit	1 Digit	1 Digit	5 Digit	In Total 31 Digits
Information	*	*****	YYMMD D	E01E05 7ALL ⁽¹⁾	1~9, A~Z	1~9, A~Z	00001	

Plain Code Information

No.	Item	Information	Digits	Remark
①	Beam angle	120° (Beam angle)	16Digit	Beam angle
②	CCT	4000K	5Digit	Refer to Page4
	Date	YYMMDD	6Digit	SMT date
③	Flux	4010lm	6Digit	Refer to Page4
	Lot No.	1	1 Digit	0~9,A~Z
	Sequence No.	00001	5 Digit	00001 ~ 99999

Notes :

(1) Module Flux code rule as below table

Symbol	lm	Symbol	lm	Symbol	lm	Symbol	lm
D91	3910	O50	14500	R50	17500	U50	20500
M20	12200	P50	15500	S50	18500	V20	21200
N00	13000	Q50	16500	T50	19500	W00	22000



Part List

Table 4. Part List Table

No	Part	Specification	Q'ty
1	LED	SZ5-M4-Wx-Cx	12
2	MCPCB PCB	Metal (Al), 146.6 x 45 x 1.6mm	1
3	CN 1, CN 2	Wago2059-302/998-403	2



Label Information

PO Number 	XXXXXX
Supplier Part Number 	SMJD-3625012H-XXN100E01E057ALL⁽¹⁾
Bin Code 	E01E057ALL⁽²⁾
Quantity 	XX
Country of Origin 	XX⁽³⁾
Date Code 	YYYYWW⁽⁴⁾
Lot Code 	YYMDDXXXXX- XXXXXXXX⁽⁵⁾
	SEOUL SEMICONDUCTOR CO.,LTD.

Notes

- (1) Please refer to SPEC page 14-15 (30 digit code)
- (2) Please refer to SPEC page 15
- (3) Country of Origin: 2 digit code . For example : KR : Korea, CN : China, VN : Vietnam
- (4) Date Code : YYYYWW : Packing Date: Year + Week
- (5) Lot Code :
Initial of manufacture is refer to the 2D code rule.
YYMDD : Packing Date (Oct. : A, Nov. : B, Dec. : C)
X : Initial of Manufacturer
XXXX : Sealing Pack No.
XXXXXXX : SSC SAP Code
- (6) It is attached to the top left corner of the box.

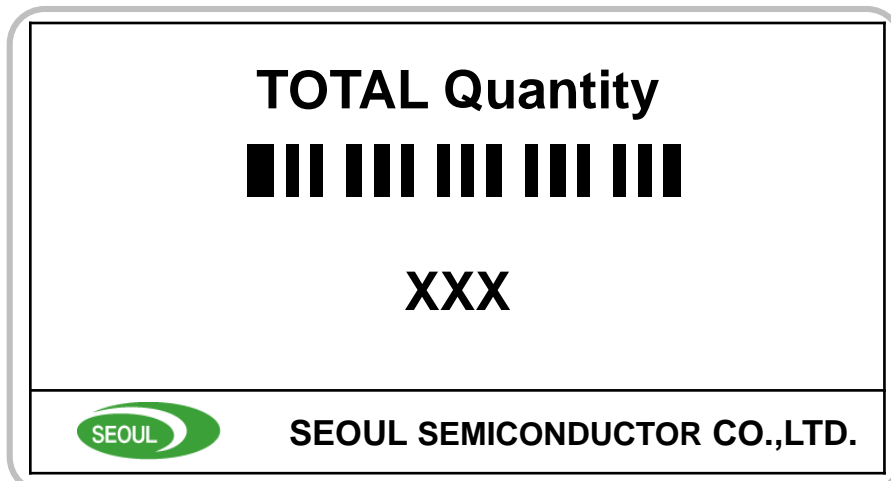

Notes

- (1) It is attached to the bottom right corner of the box.



Label Information

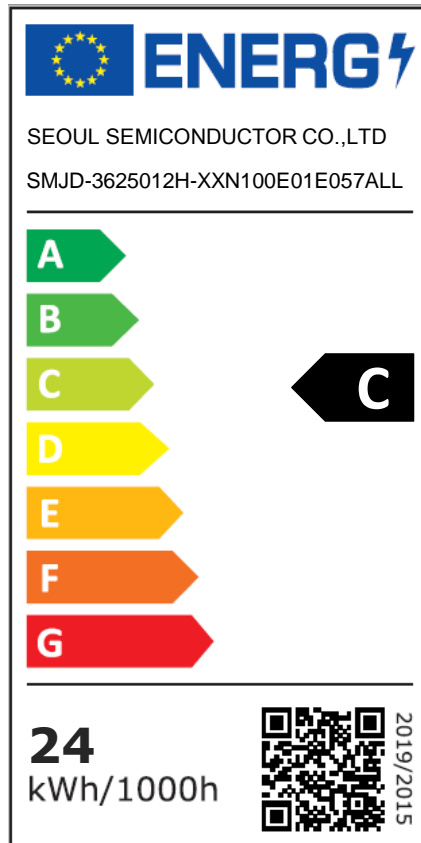

Notes

- (1) You can download the label from EPREL system
- (2) The label size should be 72mm*36mm
- (3) The background of the label shall be 100% white.
- (4) The typefaces shall be Verdana and Calibri.
- (5) Colours shall be CMYK – cyan, magenta, yellow and black, following this example: 0-70-100-0: 0 % cyan, 70 % magenta, 100 % yellow, 0 % black.
- (6) It is attached to the top right corner of the box.



Packaging Specification

1. Tray information

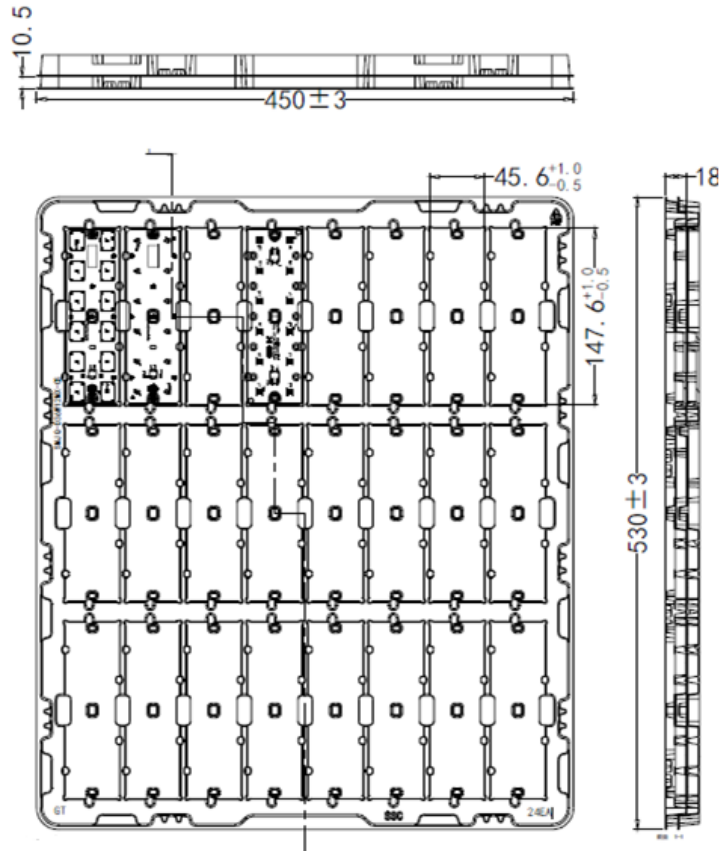

Notes:

- (1) Quantity : 24 pcs/Tray
- (2) All dimensions are in millimeters (tolerance : ± 0.3)
- (3) Scale none

2. Tray stack and taping

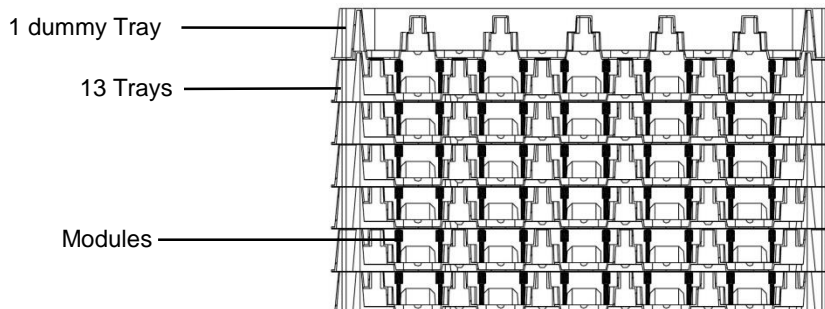

Notes:

- (1) 13 Trays and additional 1 dummy tray up of box



Packaging Specification

3. Box information & packing

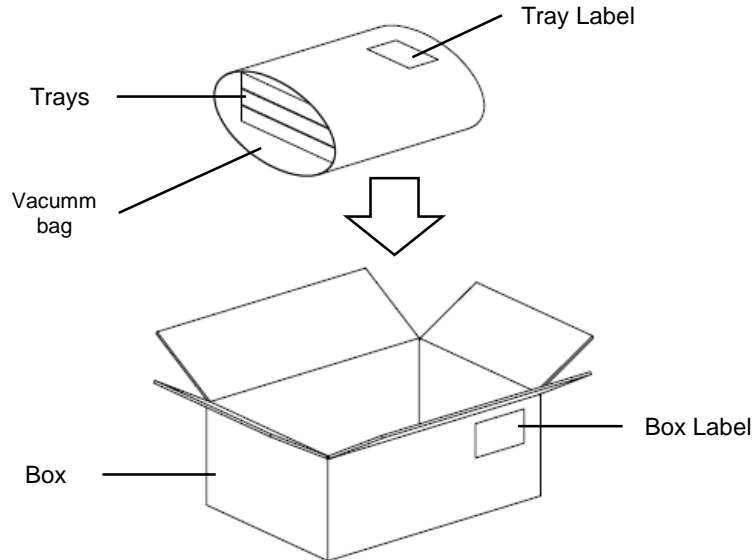
**Notes:**

- (1) Quantity : 13 Trays (13*24=312pcs) / Box
- (2) Box size : 545*465*165 mm

4. Pallet information & packing

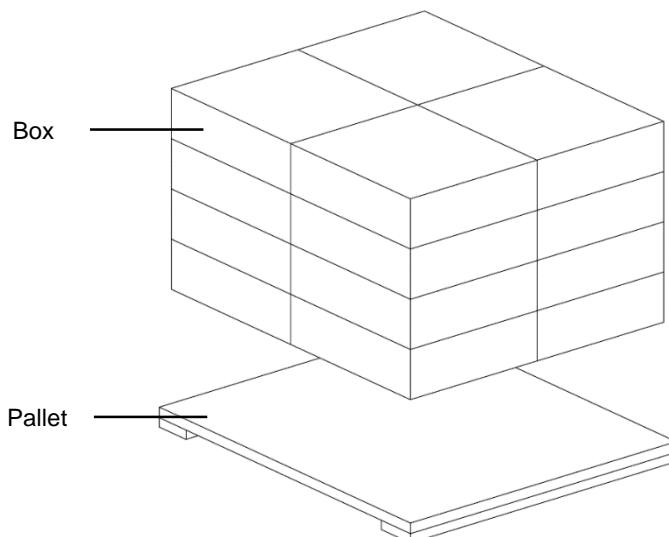
**Notes:**

- (1) Vessel Quantity: 1 Pallet = 28 Boxes = 364 Trays = 8736 Modules
- (2) Air Quantity : 1 Pallet = 24 Boxes = 312 Trays = 7488 Modules
- (3) Pallet size: 1100*1100 mm



Precaution for Use

- (1) Check the appearance of module before wiring/ assembly, DO NOT use the LED cracked or PCB damaged module.
- (2) The module was designed to be driven with DC source, recognize the polarities of the module was necessity.
- (3) It was SELV module, DO NOT connect the LED directly to main power during wiring.
- (4) DO NOT let the LED packages contacted with any hard matters.
- (5) There was no current regulator built in module, unevenly load between different parallel modules may occur due to the modules V_F variance .
- (6) Please do not use together with the materials containing Sulfur.
- (7) Please do not make any modification on module.



Precaution for Use

- (8) LEDs are sensitive to Electro-Static Discharge (ESD) and Electrical Over Stress (EOS).
Below is a list of suggestions that Seoul Semiconductor purposes to minimize these effects.

a. ESD (Electro Static Discharge)

Electrostatic discharge (ESD) is defined as the release of static electricity when two objects come into contact. While most ESD events are considered harmless, it can be an expensive problem in many industrial environments during production and storage. The damage from ESD to an LEDs may cause the product to demonstrate unusual characteristics such as:

- Increase in reverse leakage current lowered turn-on voltage
- Abnormal emissions from the LED at low current

The following recommendations are suggested to help minimize the potential for an ESD event:

One or more recommended work area suggestions:

- Ionizing fan setup
- ESD table/shelf mat made of conductive materials
- ESD safe storage containers

One or more personnel suggestion options:

- Antistatic wrist-strap
- Antistatic material shoes
- Antistatic clothes

Environmental controls

- Humidity control (ESD gets worse in a dry environment)

b. EOS (Electrical Over Stress)

Electrical Over-Stress (EOS) is defined as damage that may occur when an electronic device is subjected to a current or voltage that is beyond the maximum specification limits of the device.

The effects from an EOS event can be noticed through product performance like:

Changes to the performance of the LED package (If the damage is around the bond pad area and since the package is completely encapsulated the package may turn on but flicker show severe performance degradation.)

Changes to the light output of the luminaire from component failure

Components on the board not operating at determined drive power

Failure of performance from entire fixture due to changes in circuit voltage and current across total circuit causing trickle down failures

It is impossible to predict the failure mode of every LED exposed to electrical overstress as the failure modes have been investigated to vary, but there are some common signs that will indicate an EOS event has occurred.

- Damaged may be noticed to the bond wires (appearing similar to a blown fuse).
- Damage to the bond pads located on the emission surface of the LED package (shadowing can be noticed around the bond pads while viewing through a microscope).
- Anomalies noticed in the encapsulation and phosphor around the bond wires.
- This damage usually appears due to the thermal stress produced during the EOS event.

c. To help minimize the damage from an EOS event Seoul Semiconductor recommends utilizing

- qualified LED driver with no big over shoot out put
- Isolated driver that to prevent harmful peaks passed to module.
- A current limiting device



Storage before use

- (1) Do not impact or place pressure on this product because even a small amount of pressure can damage the product. The product should also not be placed in high temperatures, high humidity or direct sunlight since the device is sensitive to these conditions.
- (2) When storing devices for a long period of time before usage, please following these guidelines:
 - * The devices should be stored in the anti-static bag that it was shipped in from Seoul-Semiconductor with opening.
 - * If the anti-static bag has been opened, re-seal preventing air and moisture from being present in the bag.



Guidelines for properly working with Module

- (1) Discharge the lighting system a minimum of 2-3 times prior to working with the module.
- (2) Use only properly rated test equipment and tools for the rated voltage and current of the product being tested.
- (3) It is strongly suggested to wear rubber insulated gloves and rubber bottom shoes.
- (4) Do not wear any conductive items (such as jewelry) which could accidentally contact electric circuits.
- (5) Perform several tests with power off and the lighting system unplugged.
- (6) Faults, lightning, or switching transients can cause voltage surges in excess of the normal ratings.
- (7) Internal component failure can cause excessive voltages.
- (8) Stored or residual electricity in long wire could be hazardous.
- (9) Make sure proper discharge prior to starting work.



Company Information

Published by

Seoul Semiconductor © 2013 All Rights Reserved.

Company Information

Seoul Semiconductor (SeoulSemicon.com) manufactures and packages a wide selection of light emitting diodes (LEDs) for the automotive, general illumination/lighting, appliance, signage and back lighting markets. The company is the world's fifth largest LED supplier, holding more than 10,000 patents globally, while offering a wide range of LED technology and production capacity in areas such as "nPola", deep UV LEDs, "Acrich", the world's first commercially produced AC LED, and "Acrich MJT - Multi-Junction Technology" a proprietary family of high-voltage LEDs. The company's broad product portfolio includes a wide array of package and device choices such as Acrich, high-brightness LEDs, mid-power LEDs, side-view LEDs, through-hole type LED lamps, custom displays, and sensors. The company is vertically integrated from epitaxial growth and chip manufacture in its fully owned subsidiary, Seoul Viosys, through packaged LEDs and LED modules in three Seoul Semiconductor manufacturing facilities. Seoul Viosys also manufactures a wide range of unique deep-UV wavelength devices.

Legal Disclaimer

Information in this document is provided in connection with Seoul Semiconductor products. With respect to any examples or hints given herein, any typical values stated herein and/or any information regarding the application of the device, Seoul Semiconductor hereby disclaims any and all warranties and liabilities of any kind, including without limitation, warranties of non-infringement of intellectual property rights of any third party. The appearance and specifications of the product can be changed to improve the quality and/or performance without notice.



Revision History

Revision	Date	Page	Remarks
Rev0.1	2020-10-22	All	Preliminary data sheet for SMJD-3625012H-XXN1
Rev0.2	2020-11-20	11	Delete the "countersunk hole" information
Rev0.3	2020-12-01	All	Add Vf versus IF graph and Vf versus Tj and update Tj temperature
Rev0.4	2021-5-24	All	Add Ra80 parameters
Rev0.5	2021-07-15	1,16,19	Add UKCA logo and update QR construction